

VAV-Universal, modular control solution with integrated Δp sensor for polluted media. Can be combined with damper actuator optimally suited to the VAV/pressure duct application. Field of application: technical building equipment, HVAC systems

- Application: VAV/CAV units or duct pressure control in sensitive working areas with polluted media
- Functional range differential pressure 0...600 Pa
- suitable for ...-VST actuator
- Control modulating, communicative, hybrid
- Communication via BACnet MS/TP, Modbus RTU, Belimo MP-Bus or conventional control

Technical data

Electrical data	Nominal voltage	AC/DC 24 V
	Nominal voltage frequency	50/60 Hz
	Nominal voltage range	AC 19.2...28.8 V / DC 21.6...28.8 V
	Power consumption in operation	1.5 W
	Power consumption for wire sizing	2 VA plus connected VST actuator
	Power consumption for wire sizing note	Imax 20 A @ 5 ms, incl. actuator
	Connection supply / control	Terminals 2.5 mm ²
	Sensor input S1	Connection of external sensor (passive / active / switch)
	Actuator Connection (I) (M)	AC/DC 24 V, PP-Link for VST actuator
Data bus communication	Communicative control	BACnet MS/TP Modbus RTU MP-Bus
	Number of nodes	BACnet / Modbus see interface description MP-Bus max. 8
Functional data	Operating range Y	2...10 V
	Input Impedance	100 k Ω
	Operating range Y variable	0.5...10 V
	Position feedback U note	Max. 0.5 mA Options: Volume / Δp / Position
	Position feedback U variable	0...10 V Start point 0...8 V End point 2...10 V
	Override control	z1 motor stop / damper OPEN (AC/DC 24 V) z2 damper CLOSE / MAX (AC/DC 24 V)
	Parametrisation	via Belimo Assistant App / PC-Tool
Measuring data	Measuring principle	Belimo M1, diaphragm sensor
	Installation position	position-independent, no zeroing necessary
	Functional range differential pressure	0...600 Pa
	Accuracy differential pressure	± 0.6 Pa
	Maximum System pressure	1500 Pa
	Burst pressure	± 7 kPa
	Height compensation	Adjustment of system height for volumetric flow measurement (range 0...3000 m above sea level)
	Condition measuring air	0...50°C / 5...95% RH, non-condensing
	Pressure tube connection	Nipple diameter 5.3 mm for pressure tube (5 mm inner diameter)

Safety data	Protection class IEC/EN	III, Safety Extra-Low Voltage (SELV)
	Protection class UL	III, Safety Extra-Low Voltage (SELV)
	Power source UL	Class 2 Supply
	Degree of protection IEC/EN	IP42
	Degree of protection NEMA/UL	NEMA 1
	Enclosure	UL Enclosure Type 1
	EU Conformity	CE Marking
	Certification IEC/EN	IEC/EN 60730-1
	UL Approval	cULus according to UL60730-1, CAN/CSA E60730-1
	UL 2043 Compliant	Suitable for use in air plenums per Section 300.22(C) of the NEC and Section 602 of the IMC
	Mode of operation	Type 1
	Rated impulse voltage supply / control	0.8 kV
	Pollution degree	2
	Ambient humidity	Max. 95% RH, non-condensing
	Ambient temperature	0...50°C [32...122°F]
Storage temperature	-40...80°C [-40...176°F]	
Servicing	maintenance-free	
Weight	Weight	0.30 kg

Safety notes

- The device must not be used outside the specified field of application, especially not in aircraft or in any other airborne means of transport.
- Only authorised specialists may carry out installation. All applicable legal or institutional installation regulations must be complied during installation.
- The device may only be opened by lifting the cover. It does not contain any parts that can be replaced or repaired by the user.
- The device contains electrical and electronic components and must not be disposed of as household refuse. All locally valid regulations and requirements must be observed.

Product features

- Application** The VAV-Universal controller VRU-M1-BAC is used in the comfort zone as well as in sensitive working areas with polluted media. For pressure-independent control of VAV units, for recording a volumetric flow or for controlling duct pressure. See application library for description.
- Pressure measurement**
The integrated M1 differential pressure sensor is also suitable for very small volumetric flows. The maintenance-free sensor technology enables a wide range of applications in the HVAC comfort zone: residential construction, office, hotel etc. and in sensitive working areas: hospital rooms, clean rooms etc.
- Actuators**
For the various applications and damper designs, the VAV unit manufacturer has various actuator variants with running times of 2.5...120 s available.
- Control functions**
Volumetric flow (VAV/CAV), duct pressure (STP) or Position Control (Open-Loop)

Application Variable Air Volume (VAV) Variable air volume control in the V'min...V'max range, demand-dependent via a modulating reference variable (analogue or bus), e.g. room temperature, CO₂ controller for energy-saving air conditioning of individual rooms or zones.

V'nom, Δp @ V'nom

OEM specific calibration parameters, suitable for the VAV unit

Adjustment range Δp @ V'nom: 38...500 Pa

V'max / Max

Maximum operating volume flow, adjustable 20...100% V'nom

V'min / Min

Minimum operating volume flow, adjustable 0...100% V'nom

Application Constant Volume flow rate (CAV) Constant volume flow control. If required, via step switching (switching contacts) for constant volume flow applications.

Steps: CLOSE / Min / Max / OPEN

Application Volumetric flow measurement Measurement of a volumetric flow, e.g. for summation or as setpoint measurement for a common extract air box. Transmitter, without damper actuator

V'nom, Δp @ V'nom

OEM-specific calibration parameters, suitable for the measuring device

Adjustment range Δp @ V'nom: 38...500 Pa

Application Position Control (Open-Loop) Position Control for integration of the VRU-...-BAC into an external VAV control loop. Transmitter and actuator unit.

Max

Range: 20...100 % rotation range

Min

Range: 0...100 % rotation range

Application duct pressure (STP) Channel or branch pressure control in step operation (switching contacts): CLOSE / P'min / P'max or variable specification of the Δp value P'min...P'max via a continuous command variable (analogue or bus).

Lower control limit (STP) 20 Pa (from firmware V 1.04-xxxx, older firmware versions: 38 Pa)

P'nom

OEM-specific calibration parameters: 38...600 Pa

P'max

Maximum operating pressure, adjustable P'min...100% of P'nom

P'min

Minimum operating pressure, adjustable 20 Pa...100% of P'nom

Demand Control Ventilation (DCV) Output of the demand signal (damper position) to the higher-level automation system - DCV function (Fan Optimizer).

Bus operation Thanks to the multi-bus functionality of the VRU-...-BAC, the VAV universal controllers can be easily integrated into a bus system. The communication interface is defined on the system using the Belimo Assistant App: BACnet MS/TP, Modbus RTU, Belimo MP-Bus.

A hybrid mode is optionally available for BACnet MS/TP and Modbus RTU, bus connection combined with analogue control.

In bus mode, a sensor (0...10 V / passive) can optionally be connected, e.g. a temperature sensor or a switching contact, for integration into the higher-level bus system.

MP-Bus application Compatibility mode: Standard / VRP-M The VRU-...-BAC is based on the new Belimo MP data pool model. If the VRU-...-BAC is used as a VRP-M replacement in an existing MP-Bus system, the VRU-...-BAC can be set to the VRP-M function with the compatibility mode parameter. See instructions: VAV-Universal - MP-Bus Existing system: Replace VRP-M with VRU-...-BAC.

Operating settings

Control functions

Volumetric flow (VAV/CAV), duct pressure (STP - lower control limit 20 Pa) or Position Control (Open-Loop)

Operating settings Min / Max / Nominal

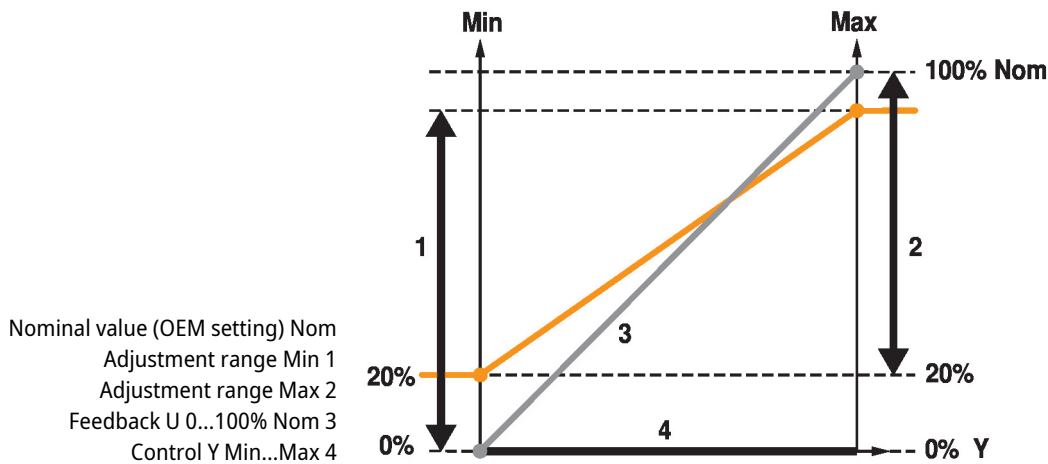

Operating and service tools

Smartphone with Belimo Assistant App - contactless operation via the integrated NFC interface.
 PC-Tool (ZTH EU) - can be locally plugged into the service socket or remotely via MP connection.

Accessories

Electrical accessories

Description

Type

Dummy plug for VST connector plug, Multipack 25 pcs.

ZG-VRU01

Tools

Description

Type

Service Tool, with ZIP-USB function, for parametrisable and communicative Belimo actuators, VAV controller and HVAC performance devices

ZTH EU

Belimo PC-Tool, Software for adjustments and diagnostics

MFT-P

Belimo Assistant App, Smartphone app for easy commissioning, parametrising and maintenance

Belimo Assistant App

Converter Bluetooth / NFC

ZIP-BT-NFC

Complete functions ZIP-BT-NFC as of production date 2019-10-15

Electrical installation



Supply from isolating transformer.

The wiring of the line for BACnet MS/TP / Modbus RTU is to be carried out in accordance with applicable RS-485 regulations.

Modbus / BACnet: Supply and communication are not galvanically isolated. Connect earth signal of the devices with one another.

Wiring diagrams

AC/DC 24 V, modulating (VAV)

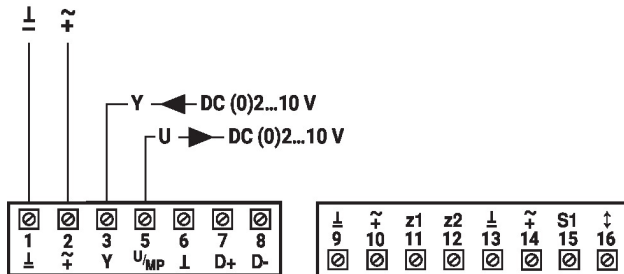

AC/DC 24 V, contactor step control (CAV)

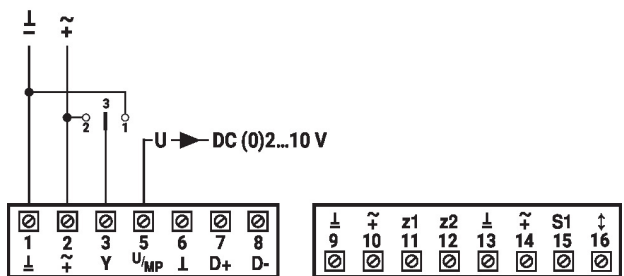

AC/DC 24 V, override control z1/z2

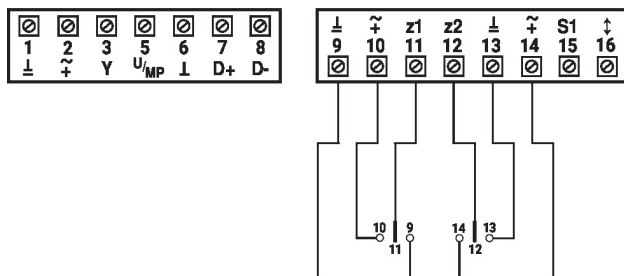
Priority rule - Analog VAV control
(a)

1. z1
2. z2
3. a) adaptation
b) synchronisation
4. Y-modulating: min...max

(see override control z1/z2)

Override command 'damper CLOSE' over reference signal Y

(in Mode 2...10 V):

< 0.3 V = damper CLOSE

> 0.3...2 V = V'min

2...10 V = V'min...V'max

Priority rule - Analogue CAV step control (b)

1. z1
2. z2
3. a) adaptation
b) synchronisation
4. Y-steps: CLOSE-MIN-MAX

(see override control z1/z2)

Contact 2-3 = MAX

3 uncoated = MIN

Contact 1-3 = CLOSE (mode

2...10 V)

MIN (mode 0...10 V)

Override control z1

Contact 11-9 = Motor STOP

Contact 11-10 = Damper OPEN

Override control z2

Contact 12-13 = Damper CLOSED

Contact 12-14 = MAX

11/12 uncoated = priority rule

a/b/c/d/e

Functions

Functions with specific parameters (NFC)

MP-Bus

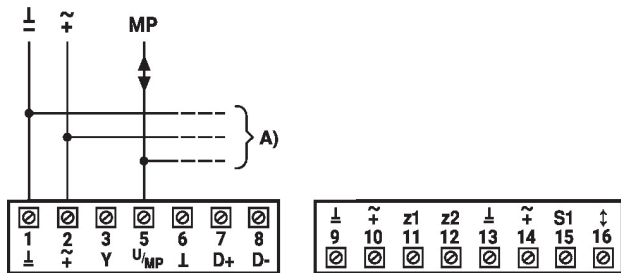

Priority rule MP-Bus control (c)

1. z1
2. z2
3. Bus watchdog
4. a) adaptation
b) synchronisation
5. Y-step: actuator CLOSED / MIN / MAX
6. Bus override
7. Bus setpoint: min...max

A) additional MP-Bus nodes (max. 8)

MP-Bus Network topology

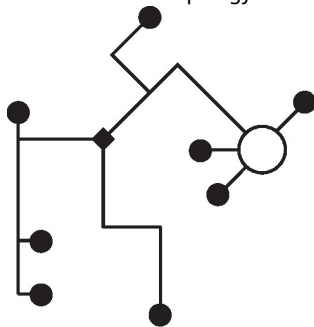

There are no restrictions for the network topology (star, ring, tree or mixed forms are permitted). Supply and communication in one and the same 3-wire cable

- no shielding or twisting necessary
- no terminating resistors required

BACnet MS/TP / Modbus RTU

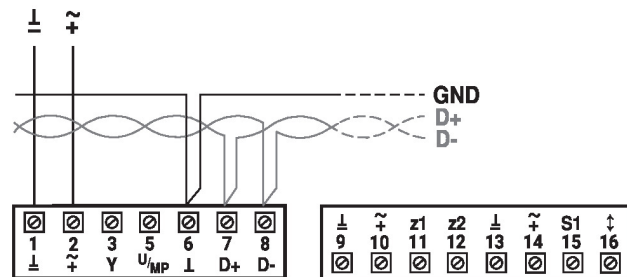

Priority rule BACnet/Modbus control (d)

1. z1
2. z2
3. Bus watchdog
4. a) adaptation
b) synchronisation
5. Bus override
6. Bus setpoint: min...max

BACnet MS/TP / Modbus RTU with analog setpoint (hybrid mode)

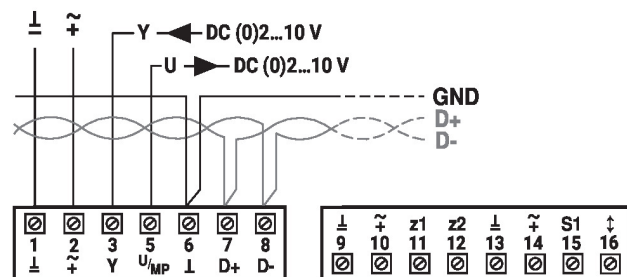

Priority rule BACnet/Modbus hybrid mode (e)

1. z1
2. z2
3. Bus watchdog
4. a) adaptation
b) synchronisation
5. Bus override
6. Y-step: actuator CLOSE / MIN / MAX
7. Bus setpoint: min...max

Connection passive sensor (bus operation)

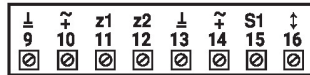
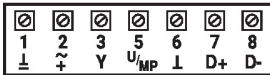

1)	2)
200 Ω...2 kΩ	0.5 Ω
2 kΩ...10 kΩ	2.7 Ω
10 kΩ...55 kΩ	14.7 Ω

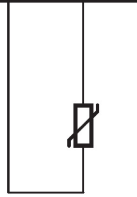

- 1) Resistance range
 - 2) Resolution
- Compensation of the measured value is recommended
 Suitable for Ni1000 and Pt1000
 Corresponding Belimo sensors 01DT-..

Connection of active sensor (bus operation)

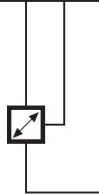
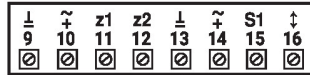
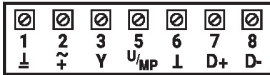

- Possible input voltage range:
 DC 0...10 V (resolution 5 mV)
 Example:
 - Active temperature sensors
 - setpoint generator
 - humidity sensor

Connection switching contact (bus operation)

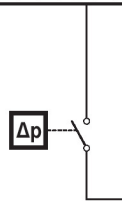
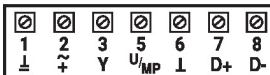

- Requirements switching contact:
 The switch must be capable of switching a current of 10 mA @ 24 V cleanly.
 Example:
 - dP sensor
 - window contact

Parameter and tool overview
Operating data

Parameter/Function	Unit/Value	Function/Description/(Area)	Application				Tool			Authorisation
			VAV/CAV	Vol. measurement	Position control	Air duct pressure	Assistant app	PC-Tool	ZTH EU	Expert/OEM
Overview										
Position	String	Plant designation (64 Z./ZTH 10 Z.)	X	X	X	X	r	r	r	
Series number	xxxxx-xxxxx-xxx-xxx	Series number VRU	X	X	X	X	r	r	r	
Voltage source	24 V/-		X	X	X	X	r			
Type	VRU-M1-BAC		X	X	X	X	r	r	r	
Application	- Volumetric flow - Measure volumetric flow - Air duct pressure	Application setting (OEM setting)	X	X	X	X	r	r	r	
Control function	VAV-CAV/Position control	Control function (OEM setting)	X		X		r	r	r	
Designation	String	Model designation unit/Damper (OEM, 16 Z.)	X	X	X	X	r	r	-	
Setpoint	VAV: m³/h/l/s/cfm (ZTH: %) Position: % Δp: Pa (ZTH: %)	Show live data dependent on the selected application	X	-	X	X	X	X	X	
Actual value	VAV: m³/h/l/s/cfm (ZTH: %) Position: % Δp: Pa (ZTH: %)	Show live data dependent on the selected application	X	X	X	X	X	X	X	
Damper position	0...100%	Show live data	X		X	X	X	X	X	
Override control	Auto/min./max./ OPEN/CLOSE/Motor stop/ Nom	Temporary override function (Tool override)	X		X	X	X	X		
Actuator	Adaption, synchronisation	Trigger adaption, synchronisation	X		X	X	X	X		E
Transmit setting data		System documentation	X	X	X	X	X	X		
Save setting data		Save setting in file	X	X	X	X		X		
Trend display	Setpoint, actual value, damper position	Commissioning, validation, service	X		X	X	X	X		
Trend display	Actual value (volumetric flow)	Commissioning, validation, service		X			X	X		
Transmit trend data		Commissioning, validation, service	X	X	X	X		X		
Diagnosis - Evaluation										
	Status									
Actuator	OK/not connected/Gear disengaged/Actuator blocked/Setting range extended/Connected actuator does not match the application		X		X	X	X	X		
Sensor	OK/Δp sensor incorrectly connected/Measuring value outside measuring range/Δp sensor error		X	X	X	X	X			
Volumetric flow / Air duct pressure	OK/Setpoint not reached		X	X	X	X	X			
Bus	OK/Bus watchdog triggered		X	X	X	X	X			
Diagnosis - Installation										
	Unit/Value	Function/Description/(Area)								
Voltage source	24 V/de-energised		X	X	X	X	X			
Operating time	h	Device connected to supply	X	X	X	X	X	X		
Active time	h	Device in motion	X		X	X	X	X		
Software Version		VRU - Firmware Version	X	X	X	X	X	X		

Availability: VAV-Universal components incl. replacement devices are only available from manufacturers of VAV units (OEM).

Authorisations: [E – Expert Mode] – Functionally relevant settings are only accessible via the Expert Mode of the Belimo Assistant App.

Legend

- X Application supports function/Parameter
- r Tool: Read
- w Tool: Write
- Tool: Does not support parameter
- E Only visible in Expert Mode

Configuration

Parameter/Function	Unit/Value	Function/Description/(Area)	Application				Tool			Authorisation
			VAV/CAV	Vol. measurement	Position control	Air duct pressure	Assistant app	PC-Tool	ZTH EU	Expert/OEM
VAV unit/Duct pressure control damper – manufacturer parameters (OEM values – not variable)										
Application	– Volumetric flow – Measure volumetric flow – Air duct pressure	Application setting					r	r	r	O
Designation	Text string	Model designation unit/Damper (16 Z.)	X	X	X	X	r	r	–	O
V'nom	m³/h/l/s/cfm	Volumetric flow nominal value	X	X	X		r	r	r	O
Δp @ V'nom	Pa	Calibration VAV unit [38...500 Pa]	X	X	X		r	r	–	O
P'nom	Pa	Nominal value Δp STP [38...600 Pa]				X	r	r	r	O
SN actuator	xxxxx-xxxxx-xxx-xxx	Actuator serial number	X		X	X	r	–	–	
Direction of rotation	ccw/cw	Actuator direction of rotation setting	X		X	X	r/w	r/w	–	E
Range of rotation	Adapted/programmed	Actuator Adapted/programmed 30...95°	X		X	X	r/w	r/w	–	E
Power on behaviour	No action/Synch. / Adaption	Actuator power-on behaviour	X		X	X	r/w	r/w	–	E
Suppress damper leakage	OFF/ON	Retrofit application, damper leakage	X				r	r	–	O
NFC interface	ON/OFF	NFC communication for app access	X	X	X	X		r	–	O
Configuration – Project specific settings										
Position	Text string	Plant designation (64 Z./ZTH 16 Z.)	X	X	X	X	r/w	r/w	r	
max.	m³/h / l/s / cfm % (Position) Pa (ZTH: %)	VAV/CAV >V'min...100% V'nom Damper position (Pos.Cntrl.) >Min...100% Δp step max >P'min...100% P'nom ¹⁾	X	X	X	X	r/w	r/w	r/w	
min.	m³/h / l/s / cfm % (Position) Pa (ZTH: %)	VAV/CAV 0...100% V'nom Damper position (Pos.Cntrl.) 0...100% Δp step min 20 Pa...100% P'nom ¹⁾	X	X	X	X	r/w	r/w	r/w	
Height compensation	ON/OFF	Switch function on/off	X	X	X		r/w	r/w	–	E
Altitude of installation	0 m	compensates Δp and volumetric flow values to the set altitude of installation (above sea level)	X	X	X		r/w	r/w	–	E
Function	VAV-CAV/Position control	Control function	X		X		r/w	r/w	–	E
Room-pressure cascade	OFF/ON	VAV: Secondary circuit room pressure cascade	X				r/w	r/w	–	E
Setpoint	Analogue/Bus	Analogue and hybrid mode/Bus	X	X	X	X	r/w	r/w	–	E
Setpoint offset	0%	VAV: ±5% compensation ETA unit	X				r/w	r/w	–	E
Reference signal Y	2...10 V/0...10 V/adjustable	Setting for VAV control	X		X	X	r/w	r/w	–	E
Feedback type	Volumetric flow/Δp/Position	VAV: Volume/Δp/Damper position Pressure: Δp/Damper position	X	(X)	X		r/w	r/w	–	E
Feedback U	2...10 V/0...10 V/adjustable	Setting U signal	X	X	X	X	r/w	r/w	–	E

1) STP application - Lower control limit: 20 Pa (from firmware V 1.04-xxxx, older firmware versions: 38 Pa).

Availability: VAV-Universal components incl. replacement devices are only available from manufacturers of VAV units (OEM).

Authorisations: [E – Expert Mode] – Functionally relevant settings are only accessible via the Expert Mode of the Belimo Assistant App.

Legend

X	Application supports function/Parameter
r	Tool: Read
w	Tool: Write
–	Tool: Does not support parameter
E	Only visible in Expert Mode

Bus parameter

Parameter/Function	Unit/Value	Function/Description/(Area)	Tool			Authori- sation
			Assistant app	PC-Tool	ZTHEU	Expert/OEM
Configuration – Communication						
Bus protocol	BACnet MS/TP/Modbus/MP		r/w	–	–	E
Bus protocol	BACnet MS/TP					
MAC address	0...127		r/w	–	–	E
Baud rate	9600/.../115200		r/w	–	–	E
Terminating resistor	OFF/ON		r/w	–	–	E
Instance number	0...4194304		r/w	–	–	E
Device name	VAV-Universal	(32 Z.)	r/w	–	–	E
Max. master	0...127		r/w	–	–	E
Bus protocol	Modbus RTU					
Address	1...247		r/w	–	–	E
Baud rate	9600/.../115200		r/w	–	–	E
Terminating resistor	OFF/ON		r/w	–	–	E
Parity	1-8-N-2/...E-1/...-O-1/...-N-1		r/w	–	–	E
Bus protocol	MP-Bus					
MP address	PP/MP1...8	PP (MP off)/MP1...8	r/w	r/w	–	E
Bus fail position	0%	0...100% (min...max)	r/w	–	–	E
Compatibility mode	Default/VRP-M ¹⁾	Default: Belimo MP datapool device VRP-M: as VRP-M replacement in existing MP system ¹⁾	r/w	r/w	–	E

Note:

¹⁾ Refer to instructions: VAV-Universal – MP-Bus existing system:
Replace VRP-M with VRU-...-BAC

Availability:

VAV-Universal components incl. replacement devices are only available from manufacturers of VAV units (OEM).

Authorisations:

[O – OEM, Manufacturer Mode] – VRU controllers are calibrated and parameterised by the unit manufacturer according to the application and project. These settings can only be changed by the manufacturer.
[E – Expert Mode] – Functionally relevant settings are only accessible via the Expert Mode of the Belimo Assistant App.

Legend:

X Application supports function/Parameter
r Tool: Read
w Tool: Write
– Tool: Does not support parameter
O Access only with OEM authorisation
E Only visible in Expert Mode

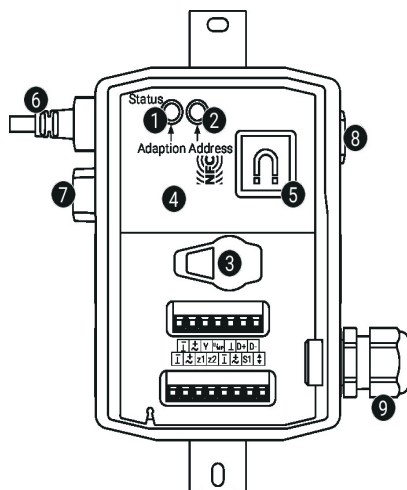
Operating controls and indicators

1 Push-button and LED display green

On: In operation (Power ok)

Flashing: Pending status information Belimo Assistant App

Press: Triggers angle-of-rotation adaptation, followed by standard mode button:

2 Push-button and LED display yellow

Flashing: MP addressing

Press button: Confirmation of the addressing

3 Service plug

For connecting parametrisation and service tools

4 NFC interface

Belimo Assistant App, over NFC interface (Android) or with ZIP-BT-NFC converter for bluetooth connection (iOS and Android Phone)

5 Mounting plate

For ZIP-BT-NFC (magnet)

6 Connection I M

For ..-VST actuator

7 Blind plug II
8 Connection Δp sensor

6 mm (tube inside diameter 5 mm)

9 Cable gland M16 (tightening torque 3 Nm)

- Installation situation** Mounting VAV-Universal control equipment:
 The VAV-Universal set is assembled on the VAV unit in the factory by the VAV unit manufacturer, the actuator is connected to the VRU controller, set and calibrated.
- Installation of the VAV unit:
 The VAV unit must be installed according to the specifications of the VAV unit manufacturer.
- Installation specification Δp sensor:
 No restrictions, but it must be avoided that any condensation can run into the sensor and remain there.
- Accessibility of control equipment:
 Accessibility to the control equipment must be guaranteed at all times.
- Cable gland M16x1.5, cable diameter 5...10 mm
 Depending on the connection situation, the cable gland can be inserted in one of the M16x1.5 openings.
- Removing the actuator:
 The connecting cable of the VST damper actuator can be removed from the VRU controller using a screwdriver (size 0...3) as shown in the illustration.
- Application without actuator:
 The unused connection socket (I)(M) can be sealed with a dummy plug ZG-VRU01, available as an accessory.
- Replacing the actuator:
 If the VST actuator is replaced during operation, the 24 V supply to the VRU controller must be briefly interrupted. This causes the corresponding actuator driver to be read in.

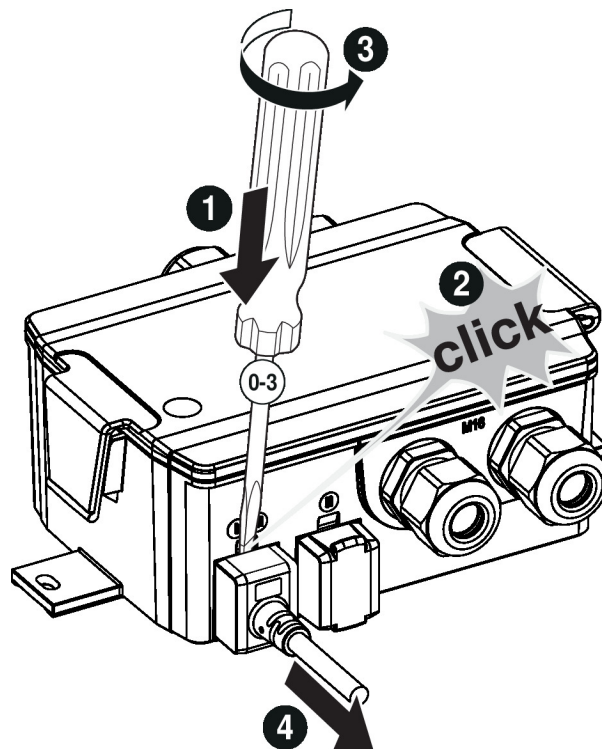

NFC connection Belimo devices marked with the NFC logo can be operated with the Belimo Assistant App.

Requirement:

- NFC- or Bluetooth-capable smartphone
- Belimo Assistant App (Google Play & Apple AppStore)

Align NFC-capable smartphone on the device so that both NFC antennas are superposed.

Connect Bluetooth-enabled smartphone via the Bluetooth-to-NFC Converter ZIP-BT-NFC to the device. Technical data and operation instructions are shown in the ZIP-BT-NFC data sheet.

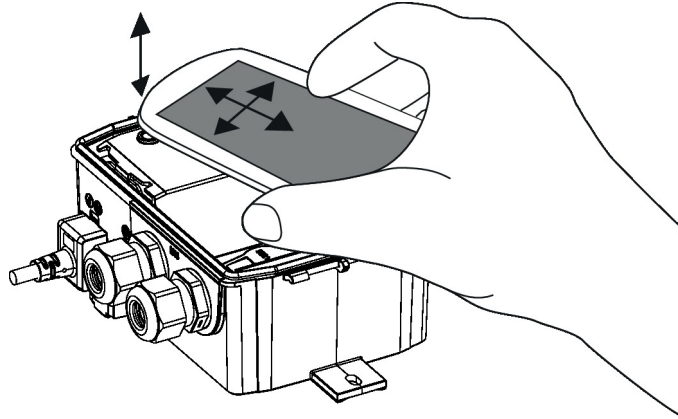

Converter ZIP-BT-NFC

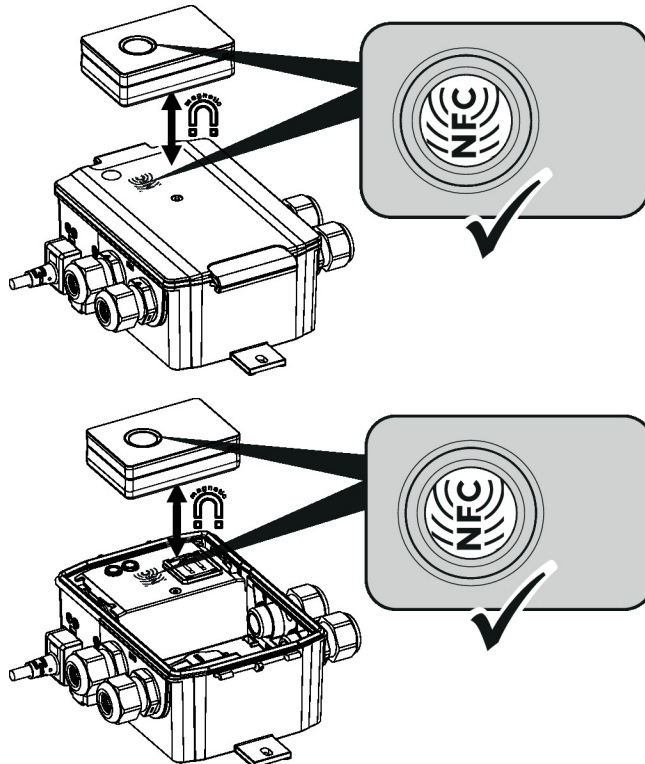

Tools connection The device can be configured by ZTH EU via the service socket or by the Belimo Assistant App via NFC.

blue = X
white = Com
green = MP

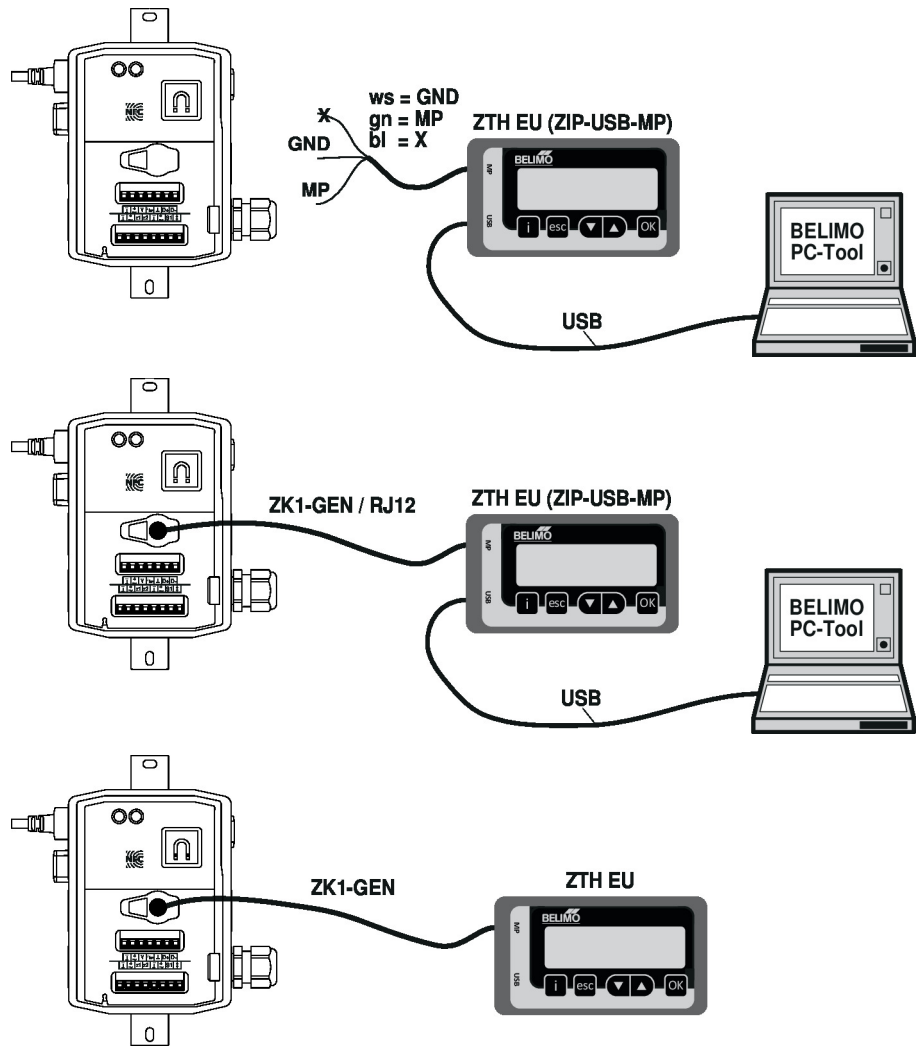

Dimensions

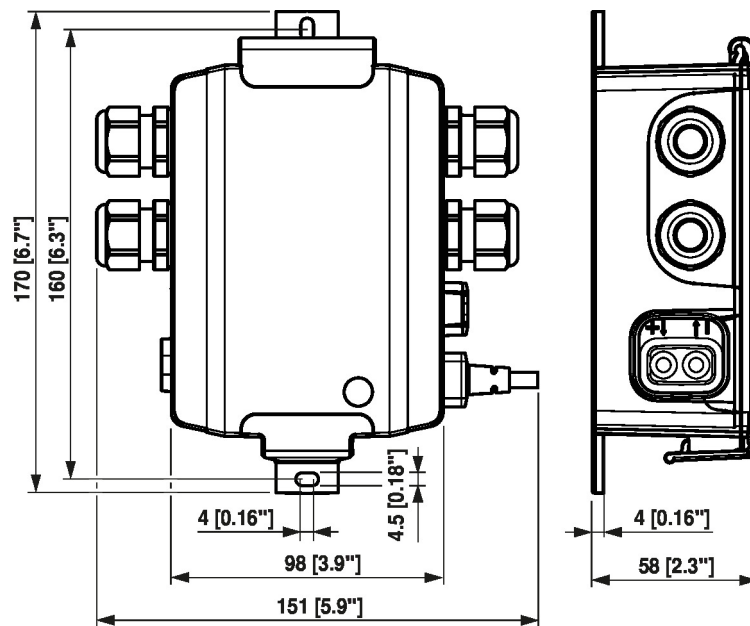

Further documentation

- Volumetric flow and pressure control from Belimo, product range overview
- Data sheets for VST-actuators
- VAV-Universal application description
- Tool connections
- Modbus Interface description
- Description Data-Pool Values
- BACnet Interface description
- Introduction to MP-Bus Technology
- Overview MP Cooperation Partners